

Cancellation of the Maternal and Extraction of the Fetal ECG in Noninvasive Recordings

Ivaylo Christov, Iana Simova, Roger Abächerli

Approach:

- Detection of the maternal QRSs
- Superimposition of P-QRS-T intervals (blue lines) and calculation of the mean signal (red line)
- Subtraction of the mean signal
- Fetal QRSs detecton

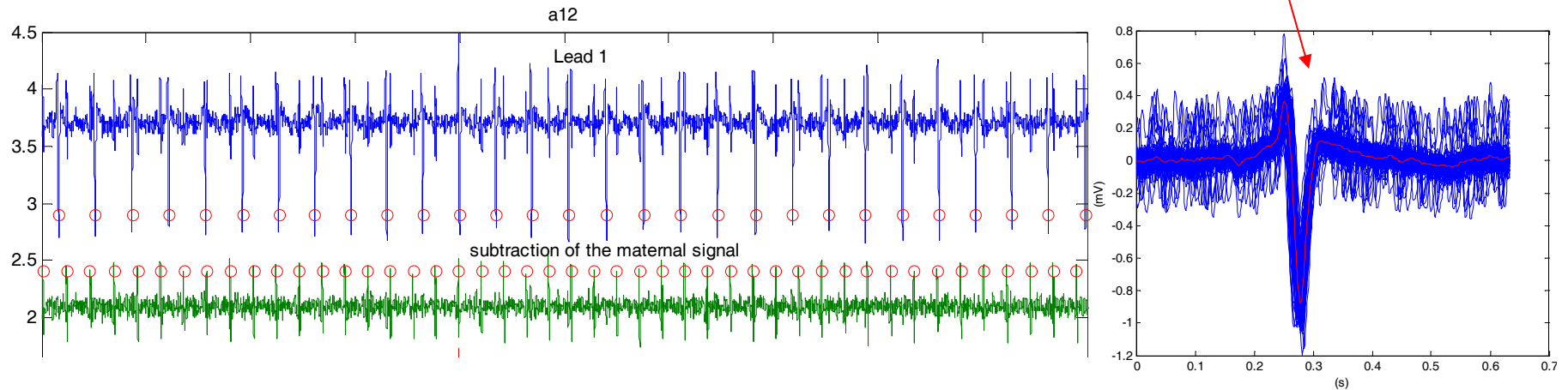

Weaknesses:

In cases of narrow and high amplitude maternal QRSs small residues remain after the cancellation of the maternal ECG. If the residues are greater than the fetal QRSs they result in false positive detections

Results:

Events 1/4, Fetal heart rate measurement: 285.132;

Events 2/5, Fetal RR interval measurement: 19.962

Extracting R-wave position from an FECG record using multichannel shapes



Approach:

1. Removing channels with low s/n ratio
2. Reducing effect of maternal ECG
3. Finding of a multichannel shape of FECG
4. Creating of preliminary annotations list
5. Finding of less-evident annotations

Programmed in C# language using .NET 4.5

Strengths:

- Capable of finding of FQRS hidden in MQRS
- Process speed (3 seconds for 1-minute record)
- Tolerates loss of channels (max. 2 from 4)
- Denominated credibility of the results

Weaknesses:

When child rotates during the recording, our method is unusable.

Results:

- Event 4 (MSE of FHR): **395.06** (Score from April 2013) -> **688.489** (The same files after change of scoring)
- Event 5 (MSE of FHR): **10.45** (Score from April 2013) -> **26.792** (The same files after change of scoring)

Feature work:

Parallelize the process. Prepare software for online FQRS detection with an experimental hardware unit.

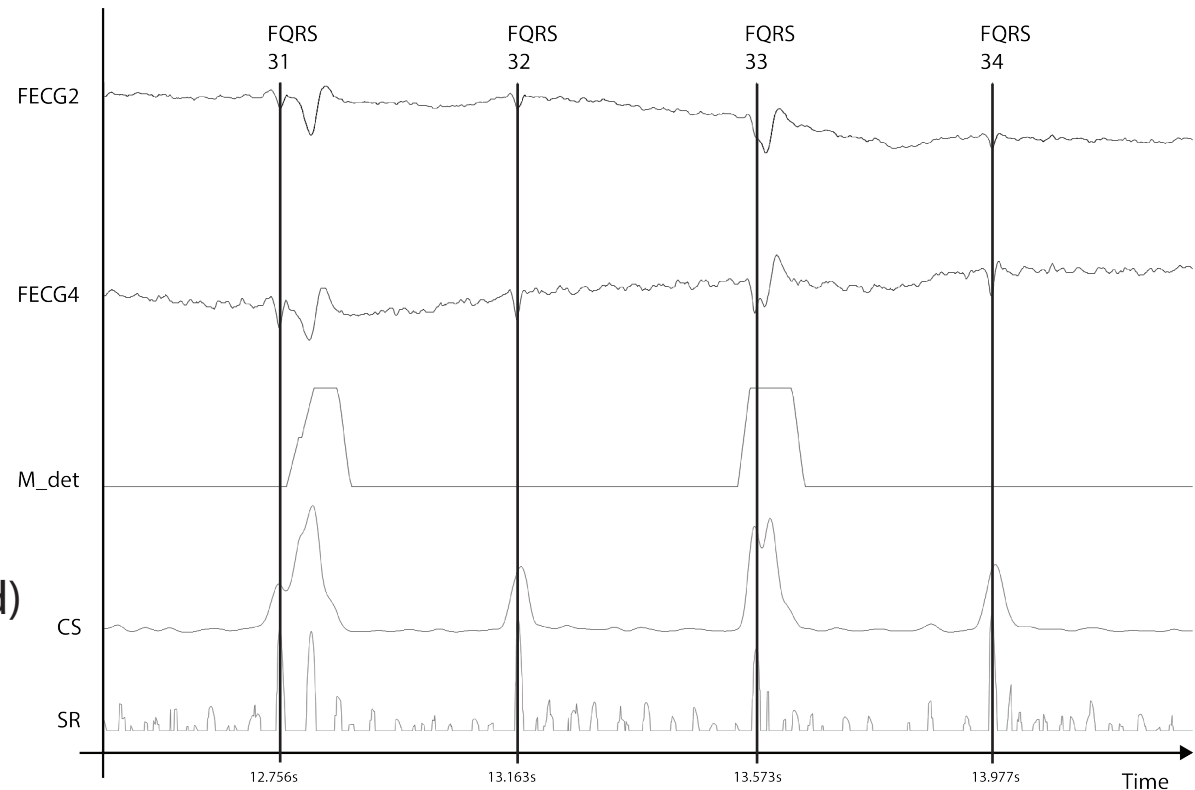

Advanced maternal ECG removal and noise reduction for application of fetal QRS detection

Jukka A. Lipponen and Mika P. Tarvainen

Approach:

- Augmented PCR model to remove maternal ECG
- Envelope method to equalize noise levels
- Multilead template matching technique to detect fQRS

Strengths:

- PCR model remove mECG successfully
- After noise equalization, template matching reveals fQRS complexes with high accuracy

Weaknesses:

- Morphological changes of fECG are troubled
- 0% accuracy, if templates are not found correctly

Results:

- Maternal ECG removed with high accuracy
- Events 4: 28.89, Events 5: 4.844

Alternatives studied / future work:

- Improvement of noise removing algorithm
- Dynamical template estimation/update
- Analysis of longer measurements

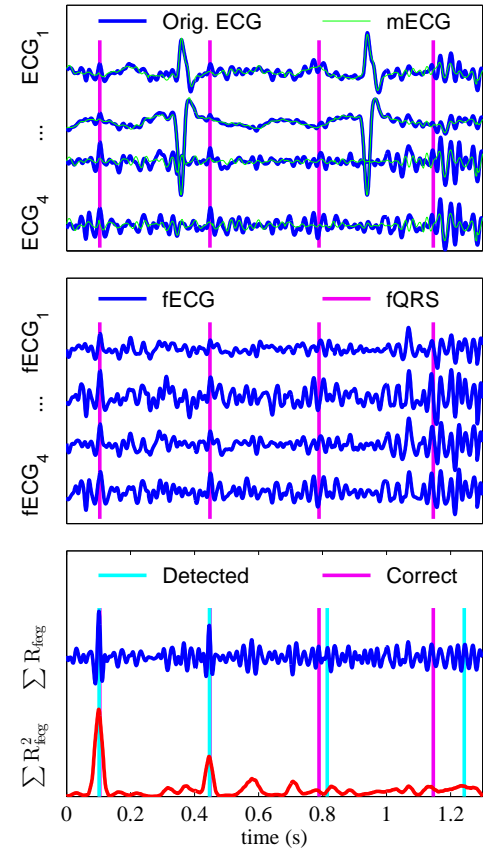

Fetal QRS detection and RR interval measurement in noninvasively registered abdominal ECGs

C Maier, H Dickhaus
Heidelberg University

Approach

Maternal ECG attenuation

PQRST Template subtraction
PCA (separate for P, QRS, T)

Fetal QRS-detection

Impulse-train „matched filter“ (energy of fRR)
„Complementary filter“ (capture noise energy)

Use $\max(MF / (MF+CF))$ in each 1s-epoch as estimate of SNR
Select fRR cand-path that corresponds with „ridge“ of SNR

Refinement of fQRS positions in final step

Results

Event 4 (MSE of fetal HR): 118.353 bpm²
Event 5 (RMS of fetal RR): 9.353 ms

Properties

- + Provides estimate of SNR
- + Robust against dynamic loss of up to 3 out of 4 leads
- + Potential not yet fully exploited
- Estimate of fRR cand-path („ridge-tracking“) is critical
- Occasional deletion of fetal QRS by PCA
- Algorithm „expects“ regular rhythm

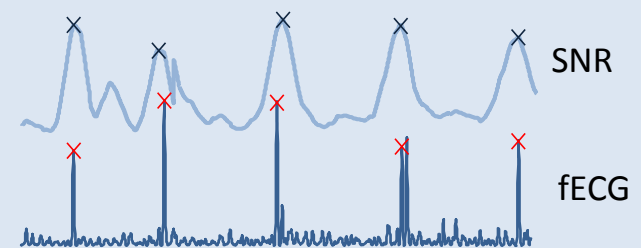
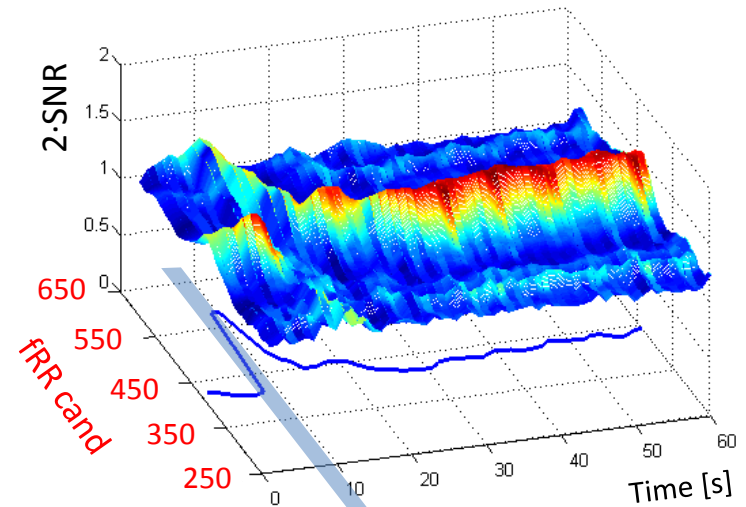
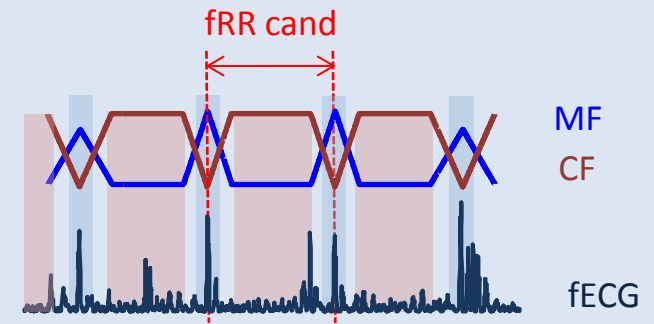

Noninvasive Fetal QRS Detection Using Linear Combination of Abdomen ECG Signals



Or Perlman, Amos Katz, Yaniv Zigel

Approach:

- Detecting a **single** FQRS and using it as an input to a modified linear combiner so that it will produce an output signal containing peaks in the respective locations of **all** FQRS complexes.

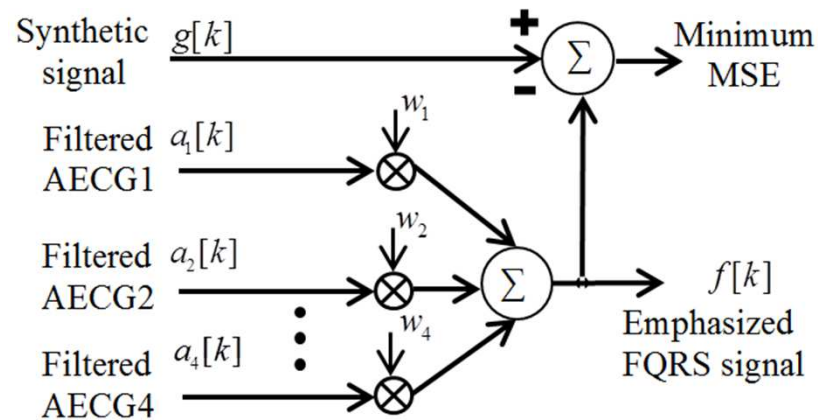

Results:

- Event 4 (MSE of fetal HR): 262.076
- Event 5 (RMS error of fetal RR): 27.848

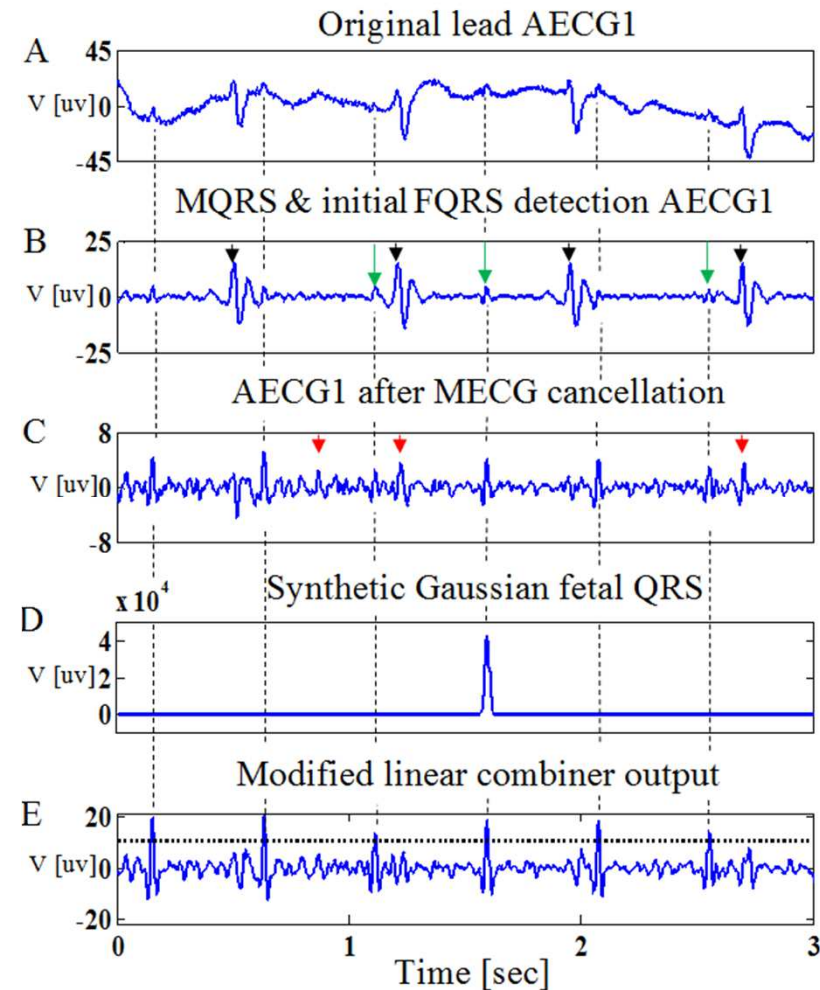

fECG Extraction From Abdominal Recordings using Array Signal Processing

Masoumeh Haghpanahi, David A. Borkholder

Approach:

- Remove mECG using Kalman filtering
- Detect polarity using a greedy algorithm
- Use hybrid time & frequency criteria to locally select and merge fECG signals
- Detect fQRS using matched filter

Observation:

- Dominant principal component could reveal fQRS when filtered fECG signals are too noisy.

Results:

- Events 1/4 (MSE of fetal HR): 50.063
- Events 2/5 (RMS error of fetal RR): 9.062

Future work:

- Study when/how to incorporate information about fQRS from principal components
- Improve signal preprocessing and initialization of dynamic model parameters

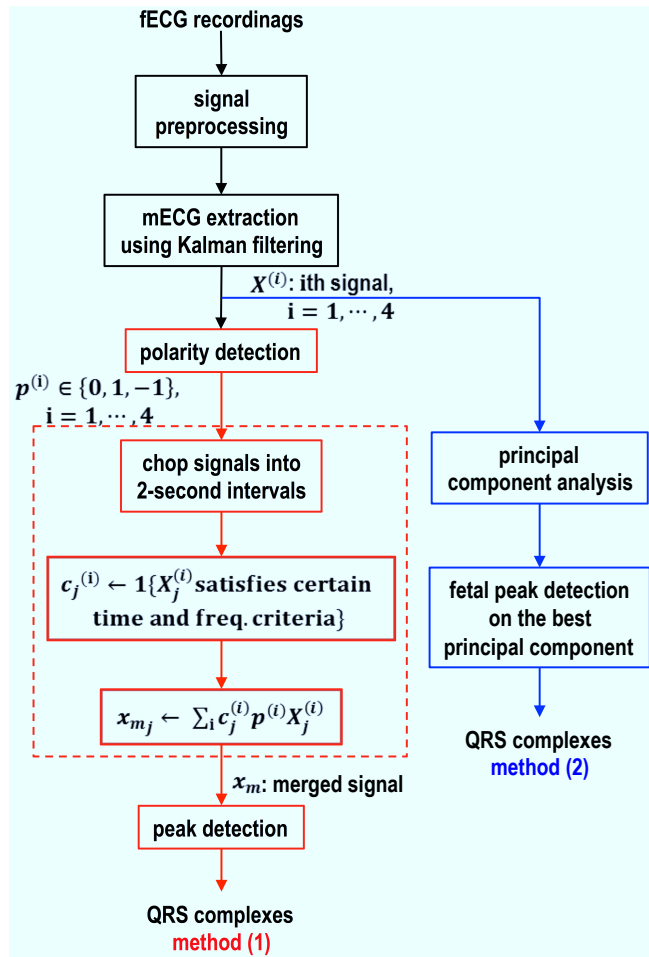

Approach:

- Set of filters to remove noises and enhance ECG
- Reuse of mECG cancellation
- Different fQRS detectors and selection of best fQRS estimate

Strengths:

- Accurate fetal RR measurement
- Uses all abdominal ECGs and selects best result

Weaknesses:

- Strongly affected by EMG
- mECG sometimes not removed properly
- QT estimation not implemented

Results:

- Events 1/4 (MSE of fetal HR): 249.8, 492.4
- Events 2/5 (RMS error of fetal RR): 22, 35.7
- Event 3 (RMS error of QT): N/A

Alternatives studied / future work:

- Correction of estimated fetal RR measurement (error detection and correction)
- Better suppression of EMG noise
- To do: QT estimation, better mECG cancellation

FQRS Detection Using Semi-Blind Source Separation Framework

F.Razavipour, M.Haghpanahi, R.Sameni

Approach:

- ECG source extraction using semi-blind source separation
- Cardiac components extraction by π CA algorithm
- Wavelet de-noising to decrease the effect of maternal ECG
- Improving the SNR of fetal ECG by matched filter

Strengths:

- Accurate estimation of cardiac components
- Preserving the fetal ECG subspace

Weaknesses:

- Not strong for single or limit channel signals
- High dependency on matched filter template

Results:

- Events 1/4 (MSE of fetal HR): 210, 216
- Events 2/5 (RMS error of fetal RR): 21, 23
- Event 3 (RMS error of QT): ?

Future work:

- Finding appropriate condition clause for de-noising loop

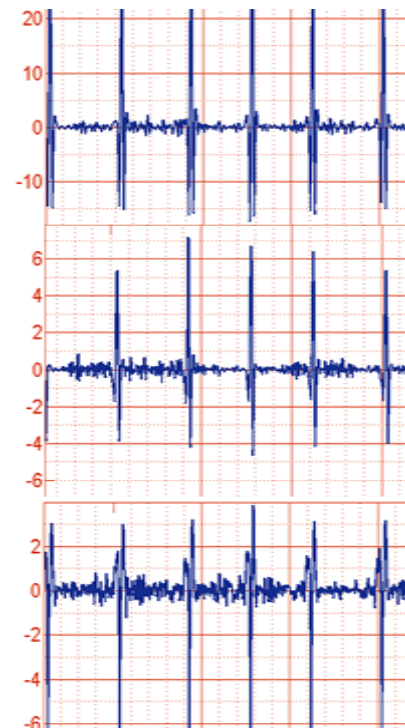

Maternal ECG, matched filtered and fetal ECG signal

Fetal QRS Complex Detection Based on Three-Way Tensor Decomposition

Mohammad Niknazar, Bertrand Rivet, and Christian Jutten

Approach:

- Tensor decomposition to extract mECG components
- Reconstruction and subtraction of mECG from mixture
- Simple peak search to detect fetal QRS

Strengths:

- Estimate mECG amplitude for each beat
- Applicable when mECG and fECG waves fully overlap
- Applicable to as few as two channels

Weaknesses:

- Not applicable to pathological mECG, where mECG morphology varies significantly

Results:

- Events 1/4 (MSE of fetal HR): 1514.59
- Events 2/5 (RMS error of fetal RR): 57.01

Alternatives studied / future work:

- Improvement of fetal QRS detection method after mECG cancellation

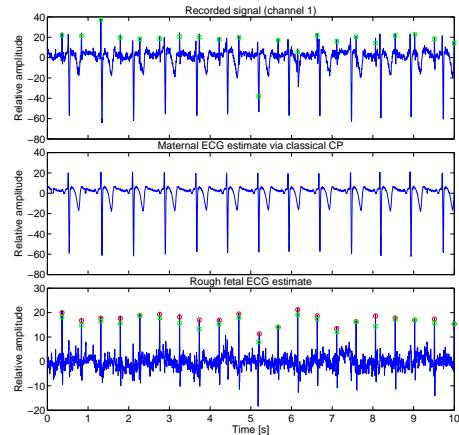
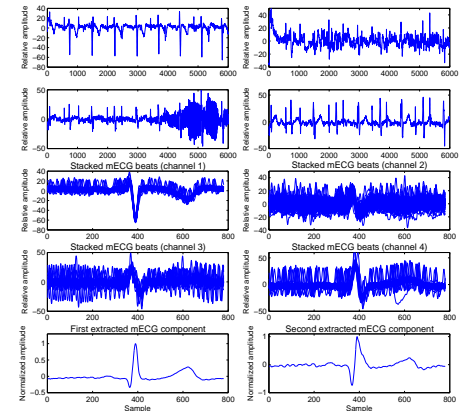

Fetal Electrocardiogram R-peak Detection using Robust Tensor Decomposition and Extended Kalman Filtering

Mahsa Akhbari, Mohammad Niknazar, Christian Jutten,
Mohammad B. Shamsollahi, Bertrand Rivet

Approach:

- Reconstruct mECG by tensor decomposition
- Rough estimate of fetal R-peak positions
- Tensor decomposition to reconstruct rough fECG
- Extended Kalman filter (EKF) with 25 states for fetal R-peak detection, in which ECG beat is modeled by 3 state equations (P, QRS and T)

Strengths:

- Estimate rough denoised fECG
- Estimate fetal R-peaks accurately

Weaknesses:

- Demand accurate initial values of EKF Parameters

Results:

- Events 1/4 (MSE of fetal HR): 1326.21
- Events 2/5 (RMS error of fetal RR): 45.06

Alternatives studied / future work:

- Propose automatic method robust to initialization of values of EKF parameters

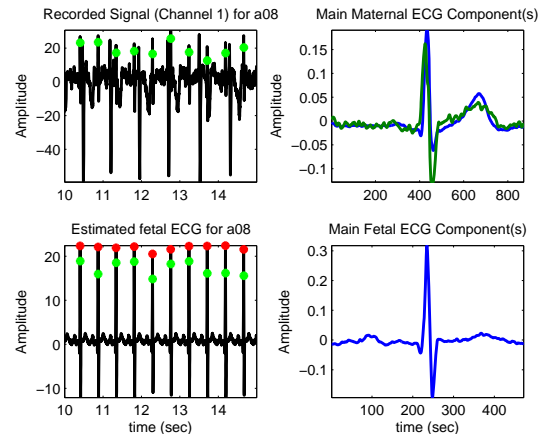

Maternal signal estimation by Kalman Filtering and Template Adaptation for fetal heart rate extraction

F. Andreotti, M. Riedl, T. Himmelsbach, D. Wedekind, S. Zauneder, N. Wessel, H. Malberg

Approach:

- Maternal QRS detector (ICA + decision making + matched filter)
- Kalman Smoother (EKS) / Template Adaption (TA) to estimate mECG
- Simulated annealing based fetal QRS (fQRS) detector
- Statistical decision-making and corrections (fQRS postprocessing)

Strengths/Weaknesses:

- Extreme reliable fetal detections
- Tolerates missing peaks (postprocessing)
- Expected HR information leads to errors if fHR strongly varies
- EKS crosses fetal peaks out

Results (Set-B):

- Events 1/4 (MSE of fetal HR): 20.43 (TA) 219.46 (EKS)
- Events 2/5 (RMS error of fetal RR): 4.57 (TA) and 7.69 (EKS)
- Best result: 18.08 / 4.38 (10x TA)

Future work:

- Validate maternal QRS detector
- Improve EKS for further combination with TA

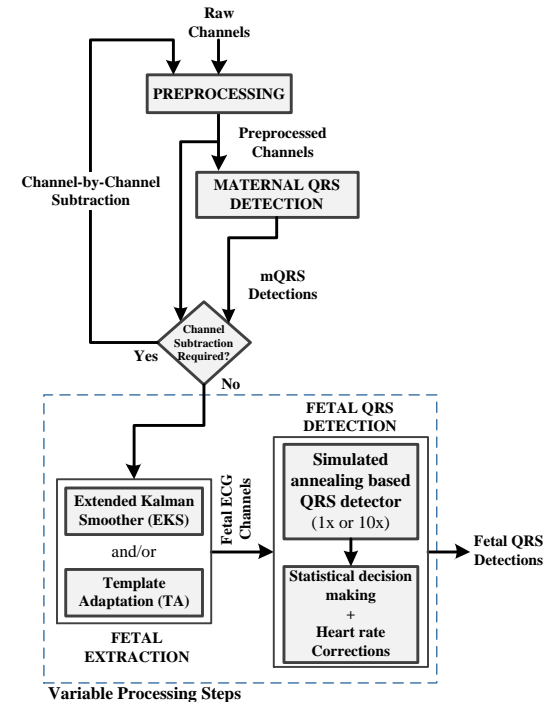

Signal processing chain.

Spatial filtering and adaptive rule based fetal HR extraction from abdominal fetal ECG

Minnan Xu-Wilson, Eric Carlson, Limei Cheng and Srinivasan Vairavan
Philips Research North America (PRNA), Briarcliff Manor, NY, USA

Approach:

- Spatial filtering (PCA and Orthogonal Projection) to attenuate maternal ECG (MECG)
- PCA clustering and adaptive rule based fQRS detection
- Merge fQRS from different approaches for an accurate fQRS detection

Strengths:

- Accurate fetal RR measurement
- Capable of handling low signal-to-noise ratio fQRS

Weaknesses:

- Cardiac residues after MEGC attenuation
- Adaptive fQRS beat insertion may not be at true QRS location

Results:

- Events 4 (MSE of fetal HR): 52.496
- Events 5 (RMS error of fetal RR): 10.618

Alternatives studied / future work:

- Better MEGC attenuation techniques
- Better fQRS beat insertion techniques

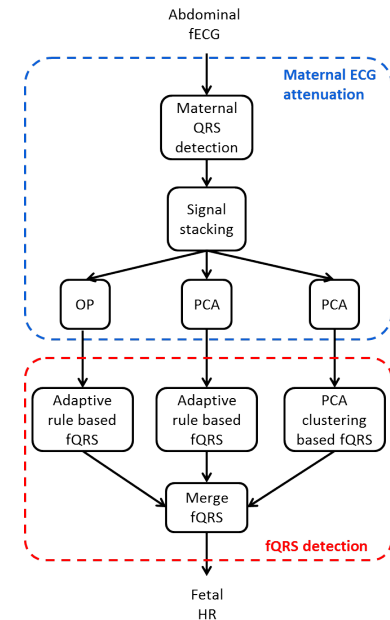

A Robust Framework for Noninvasive fECG Extraction

Marzieh Fatemi, Mohammad Niknazar, Reza Sameni

Approach: MINC

- DEFL \implies mECG removal
- Iterative PCA denoising \implies fEEG removal
- Kalman Filter \implies fECG Enhancement

Strengths:

- Single and multichannel, temporal and statistical properties of the ECG

- No additional assumption:

Full rank noise, correlated and/or distributed sources

- Preserving dimensionality:

Multichannel fECG, more interpretive for physicians than ICA)

Results on data test:

- Events 1/4 (MSE of fetal HR): 291.458, 274.268
- Events 2/5 (RMS error of fetal RR): 33.016, 32.085

future work:

- Automatic estimation of effective Dimension and number of Iterations using quality assessment criteria

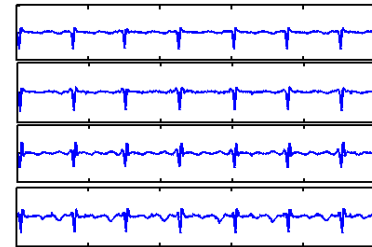

Preprocessed Signal

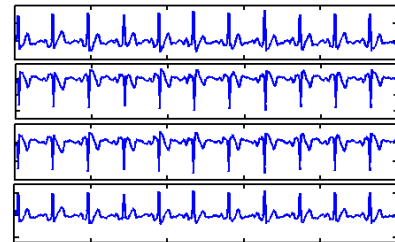

Extracted fECG after denoising

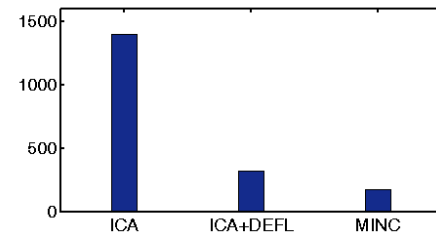

The error Score comparison on data train

Noninvasive Fetal QRS Detection Using Echo State Network

Mantas Lukoševičius*, Vaidotas Marozas / Kaunas University of Technology, Lithuania

Approach:

1. Mean m ECG cycle removed
2. Trained Echo State Network indicates $P(t)$ of fR
3. Dynamic Programming includes $fQRS$ statistics $P(t|t_{-1})$, $P(t|t_{-1}, t_{-2})$ to find the next fR event t

Strengths:

- Good accuracy, robust, fast (2x real time)
- Generic and adaptable: works even without (1.)

Weaknesses:

- Quality training data is vital
- No fQT measurements (yet?)

Results:

- Event 4 (fHR): **66.327**, 147.236
- Event 5 (fRR): 11.027, **8.239**

Alternatives studied / future work:

- Using $P(t|t_{-1})$ and $P(t|t_{-1}, t_{-2})$ gives different benefits. A better combination of P 's in (3.)?
- A more rigorous comparison of different (3.) algorithms.
- Performance can be improved sacrificing speed: bigger networks (2.); also with better (1.)

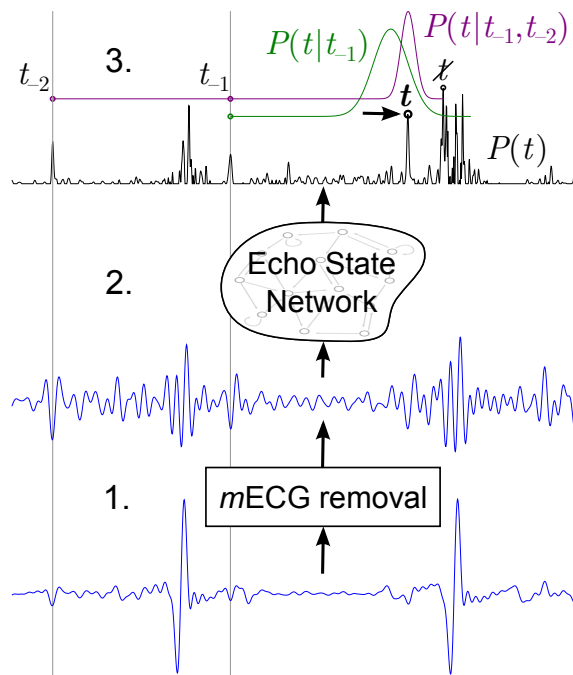

A multi-step approach for non-invasive fetal ECG analysis



Approach:

1. Pre-processing to remove baseline and power line
2. ICA to enhance maternal ECG
3. Interpolation 4 KHz and maternal QRS detection
4. SVD to remove maternal ECG using QRST approximation
5. ICA to enhance fetal ECG
6. Fetal QRS detection improved with AR model of RR series

Strength:

- The combination of ICA and SVD improves the cancellation of maternal ECG
- The second ICA enhances fetal ECG

Weaknesses:

- Measurement/EMG noise impairs the effects of ICA
- Trade-off Maternal ECG cancellation/fECG preservation

Results:

- Events 1/4 (MSE of fetal HR): 187.091, 33.952
- Events 2/5 (RMSE of fetal RR): 20.975, 5.098

Conclusions/future work:

- Improving fQRS detector to manage inaccurate maternal ECG cancellation
- Avoid SVD canceling when ICA separates the fECG source

ICA separated sources

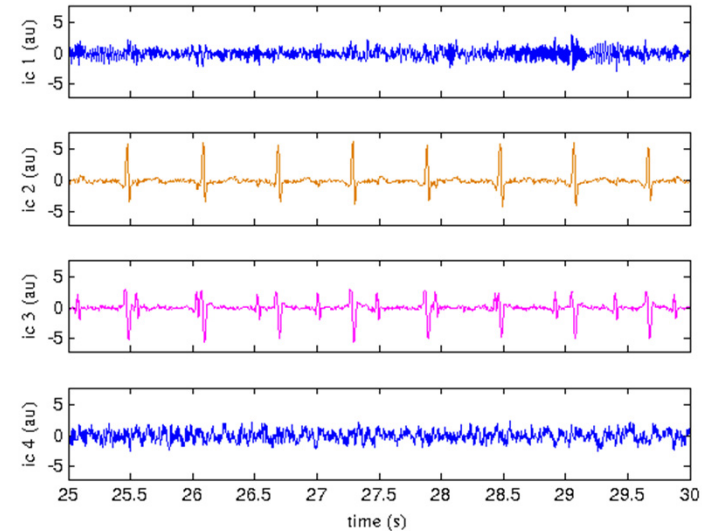

SVD cancellation

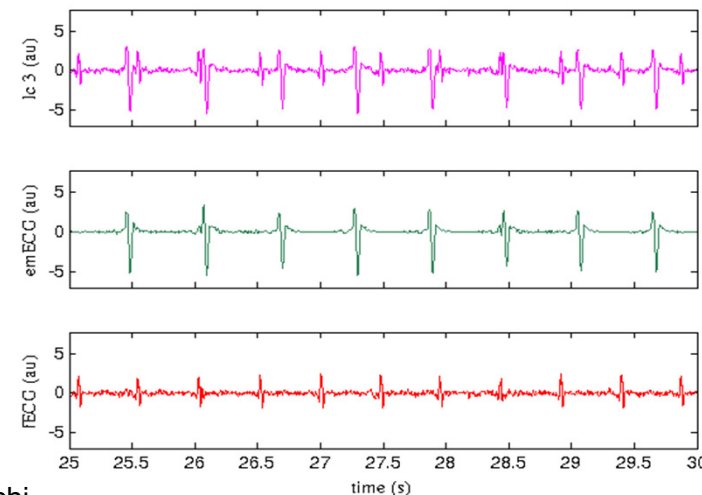

Approach:

- Average heartbeat to remove maternal ECG
- PCA, ICA, π CA decomposition to enhance FECG
- Wavelet based delineator to detect/delineate fQRS
- SNR measure based in coherent averaging
 - Statistical model to accept measurements

Strengths:

- Exploits well spatial separation
- Specific

Weaknesses:

- Spatial overlapp
- Sensitivity

Results:

- Events 4 (MSE of fetal HR): 4714.6
- Events 5 (RMS error of fetal RR): 121.6

Alternatives studied / future work:

- Ensure spatial separation
- Improve statistical model of fQRS

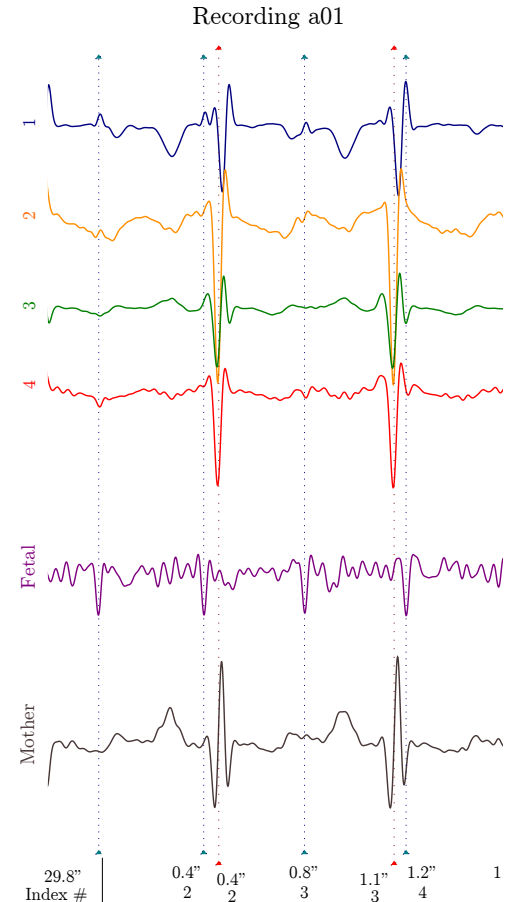

A WT Meth. for Assessing Fetal Cardiac Rhythms from Abdominal ECGs

Rute Almeida, Hernâni Gonçalves, Ana Paula Rocha, João Bernardes

Goal: WT based ECG delineator → fetal QRS detector using similar strategy → **score 5**

Approach: similar to maternal QRS detection

- search Maximum Modulus Lines across scales
- QRS: zero crossings between MML
 - refractory period and searchback
- combine SL marks: one annotation
- **Adapting for fetal physiology:**
 - adapt scales, thresholds and time neighborhood
 - maternal QRS MML lines → excluded

Results:

- set A: score 27 / Sensitivity 78% / +Predictivity 82%
- set B: score 33
- detect overlaped fetal/maternal QRS (**strength**)
- arbitrary number of leads (1, 2, ...) (**strength**)
but affected by artifacts in more than 1 lead (**weakness**)

Future improvements:

- to reduce FP by minimum signal quality restrictions

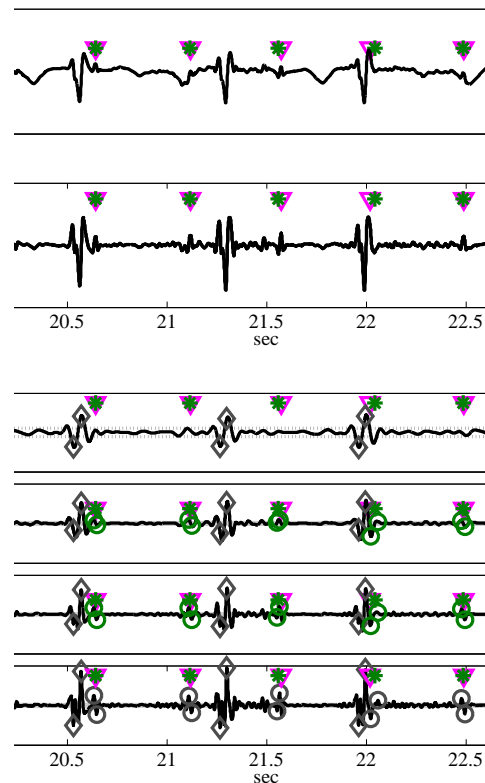

Intelligent Recognition of the Fetal QRS Complex

Ali Ghaffari¹, Seyyed Abbas Atyabi¹, Mohammad Javad Mollakazemi^{1*}, Maryam Niknami², Ali Soleimani¹

¹CardioVascular Research Group (CVRG), Department of Mechanical Engineering at K.N.Toosi University of Technology, Tehran, Iran

²Cardiovascular Division of Imam Hossein Hospital, Isfahan University of Medical Sciences, Golpayegan, Iran

Approach:

- 1.Regenerating the missing data based on the statistical distribution of the data.
- 2.Preprocessing and denoising the FECG signal using wavelet transform based on estimation of noises of wavelet coefficients .
- 3.Decomposing the denoised signal using discrete wavelet transform in level 10 with 'db6' wavelet function
- 4.Reconstructing signal of details 1 , namely as D1 signal
- 5.Finding Maternal QRS complex from original signal
- 6.Eliminateing Maternal QRS complex from D1 signal
- 7.Find other high frequency points (using D1 signal)
- 8.Keep high frequency points that have an special order and memorize the order
- 9.Approximate the other points using the order
- 10.Do these steps for all 4 leads
- 11.Score the leads with 2 parameters:
 - a=less noise distribution
 - b=having more proper members in step 10
- 12.Select the more reliable members of step 10 vectors
- 13.Combine the reliable members of the leads with a priority (the priority is the score of leads)
- 14.Predict the eliminated FQRS
- 15.Combine step 13 and 14 outputs

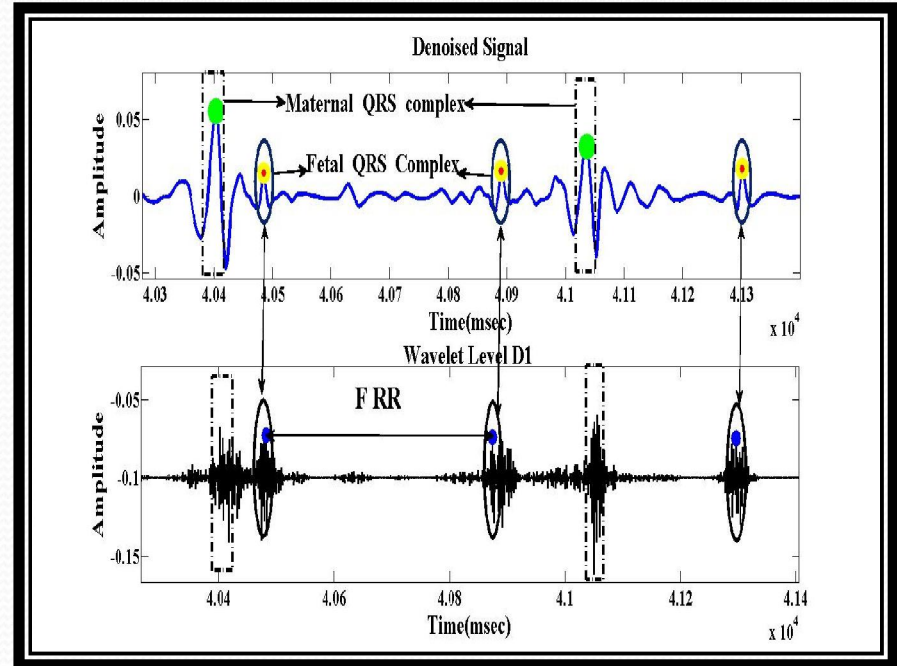

Results (Best Scores):

Events 4 and 5 from phase 1 : **108.766 and 15.480**

Events 4 and 5 from phase2: **63.750 and 11.198**

❖ Approach

FUSE

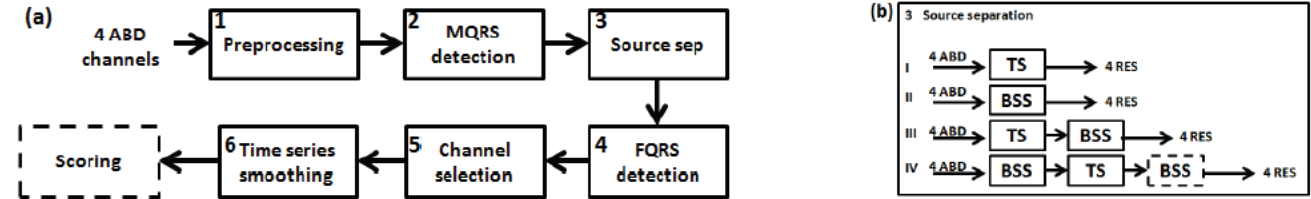

Figure 1. (a) FECG extraction block diagram. (1) The four ABD ECG channels are preprocessed, (2) MQRS detection, (3) source separation to extract the FECG from the ABD mixture, (4) FQRS detection, (5) one of the FQRS time series is selected, and (6) the resulting time series is smoothed. (b) Detail of the source separation block. ABD: abdominal, BSS: blind source separation, RES: residual, dashed line: optional step.

❖ Strengths

Robust extraction and selection of ABD channel

❖ Weaknesses

QT measurement requires different extraction condition

❖ Results

E4=29.6, E5=4.67

❖ Future work

- Better way of fusing information from the different residuals
- Evaluation on larger database
- Evaluation on pathological examples

CL Method		HRE	RRE	F ₁ -10Hz	F ₁ -2Hz
		NU	NU	%	%
I	TS	656	27.9	81.6	81.1
I	TS _{PCA}	594	21.6	86.0	83.7
I	TS _{EKF}	841	26.2	82.0	79.9
II	ICA	2852	39.3	63.8	61.7
II	PCA	3891	45.3	51.6	52.6
III	TS-ICA	272	17.1	92.0	91.4
III	TS _{PCA} -ICA	156	16.9	93.0	92.4
III	TS _{EKF} -ICA	565	27.3	81.1	80.7
IV	ICA-TS	430	19.2	90.6	89.3
IV	ICA-TS-ICA	369	18.7	91.7	91.1
CONST-HR (143 bpm)		172	8.9	22	–
FUSE		136	12.5	95.0	94.6
FUSE-SMOOTH		16	6.3	96	–
FUSE-CHALL		4.8	2.3	74.5	–

Table 2. Performance of the different algorithms on set-a. TS: template subtraction, HRE: score for the heart rate challenge event, RRE: score for the RR challenge event, CL: class of the method, NU: no unit. F₁-10Hz and F₁-3Hz represent the F₁ measure with $f_{bas}=10\text{Hz}$ and $f_{bas}=2\text{Hz}$ respectively. HRE and RRE are given for $f_{bas}=10\text{Hz}$.

Multi Stage Principal Component Analysis Based Method for Detection of Fetal Heart Beats in Abdominal ECG



LIETUVOS SVEIKATOS
MOKSLŲ UNIVERSITETAS

¹ Lithuanian University of Health Sciences, Kaunas, Lithuania

² Kaunas University of Technology, Kaunas, Lithuania

Robertas Petrolis¹, Algimantas Krisciukaitis^{1,2}

Approach:

- R wave detection by two stage method using amplitude thresholding and maximization of correlation with sliding QRS template.
- Mother's ECG elimination by means of cardio cycle-wise Principal Component Analysis and truncated representation using only 3 first eigenvectors.
- Fetal ECG concentration into one lead by means of Principal Component Analysis of all signal leads after Mother's ECG cancellation.
- R wave detection in fetal ECG by means of two stage method using amplitude thresholding and maximization of correlation with sliding QRS template.

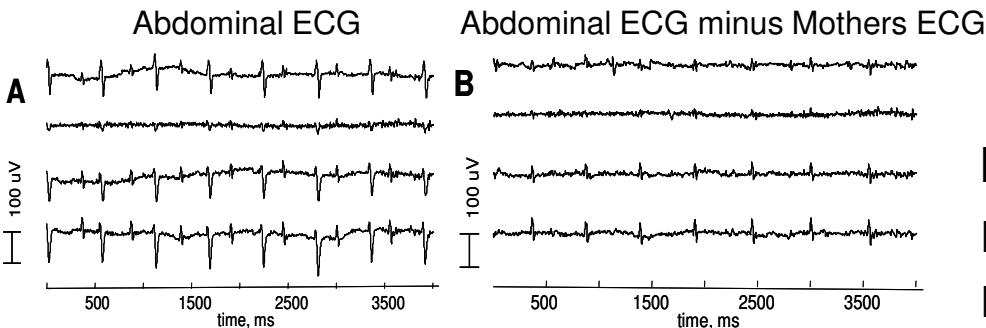

Strengths:

- Based on biophysical interpretation of the signal origin;
- As side product, provides morphological estimates of cardio cycles.
- No training set is required.

Weaknesses:

- Many parameters of the method are defined and adjusted “ad hoc”: number of principal components, threshold levels etc.
- Possibility to analyze only intervals of certain minimal length.

Stars – our method, circles - reference time points

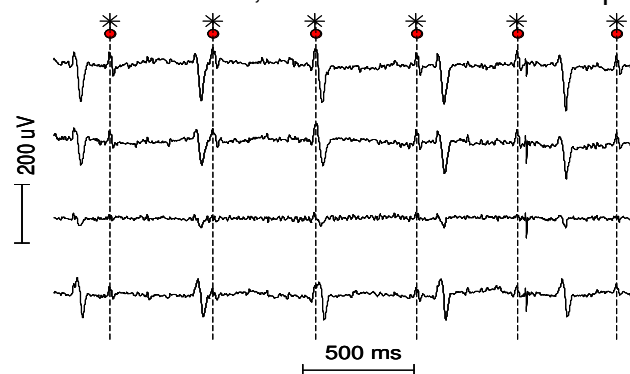

Results:

Events 4 (MSE of fetal HR): 341.503

Events 5 (RMS error of fetal RR): 32.810

Alternatives studied / future work:

- We tried “classical” ICA, but it failed due to significant part of the signal energy occupied by independent noise components.
- Cardio cycle-wise reconstruction of fetal ECG by means of PCA for morphological analysis of the signal.

An Algorithm for the Analysis of Foetal ECG from 4-channel Non-invasive Abdominal Recordings

Di Maria C, Duan W, Bojarnejad M, Pan F, King S, Zheng D, Murray A, Langley P

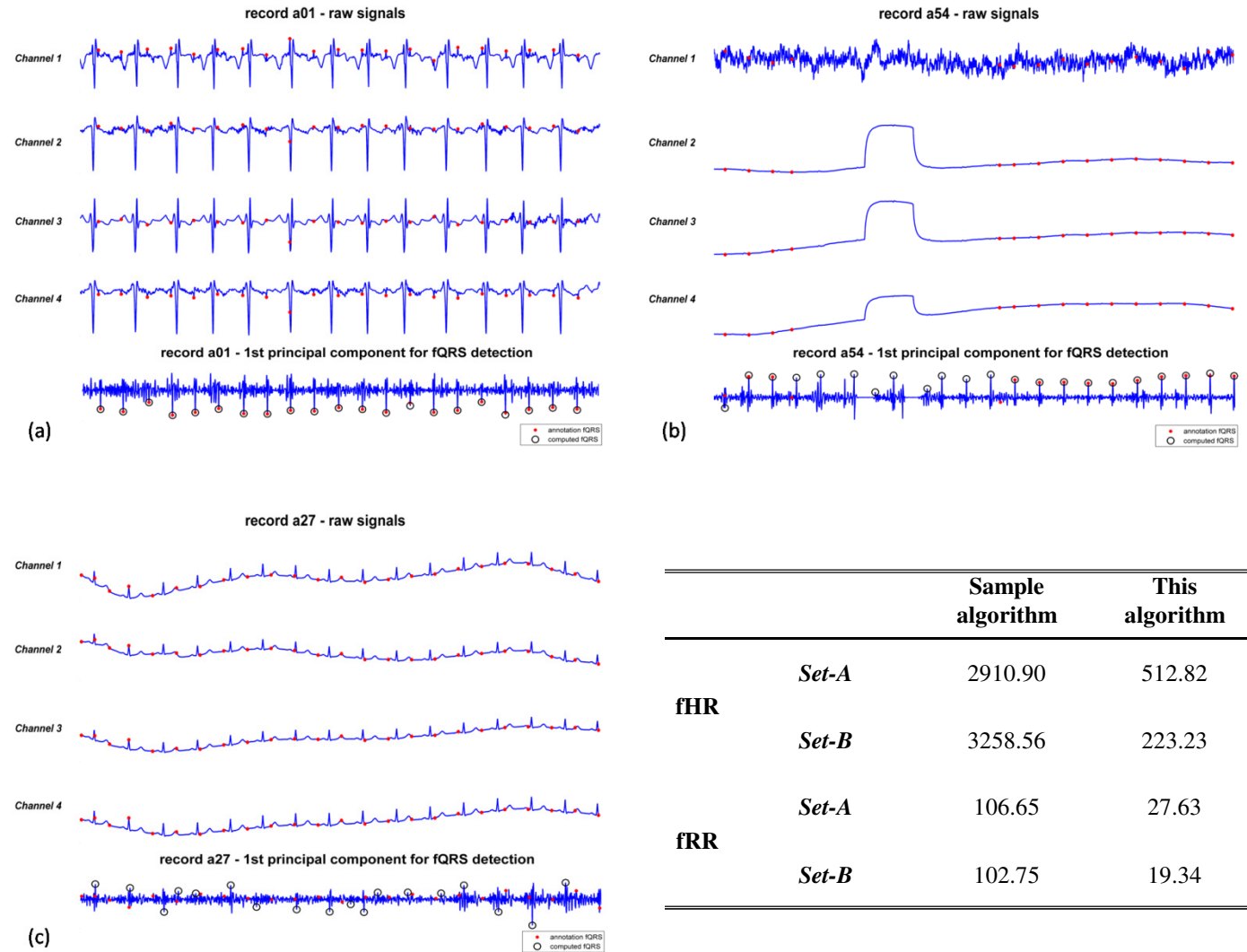
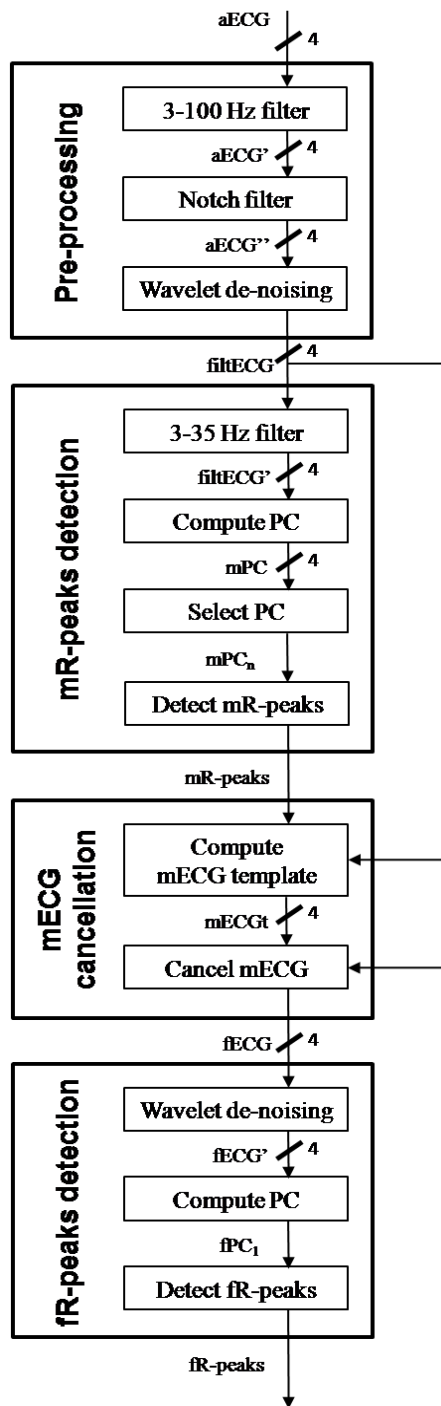

		Sample algorithm	This algorithm
fHR	<i>Set-A</i>	2910.90	512.82
	<i>Set-B</i>	3258.56	223.23
fRR	<i>Set-A</i>	106.65	27.63
	<i>Set-B</i>	102.75	19.34



Systematic Methods for Fetal Electrocardiographic Analysis: Determining the Fetal Heart Rate, RR Interval and QT Interval



Chengyu Liu and Peng Li

Method: algorithm flow chart

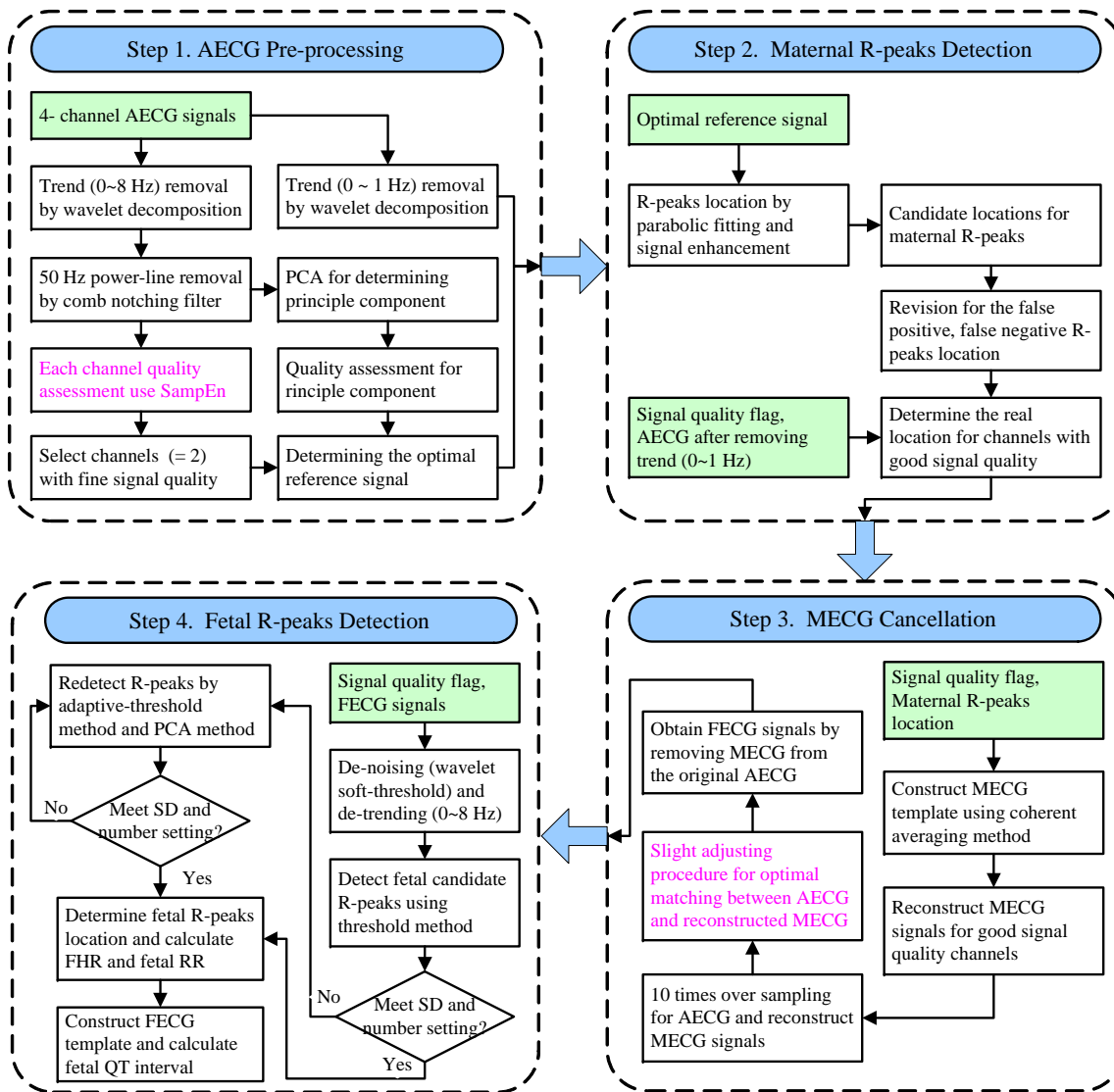

Results on Set B

Event 4: 264.87; Event 5: 9.04

Record a40: raw AECG and optimal FECG

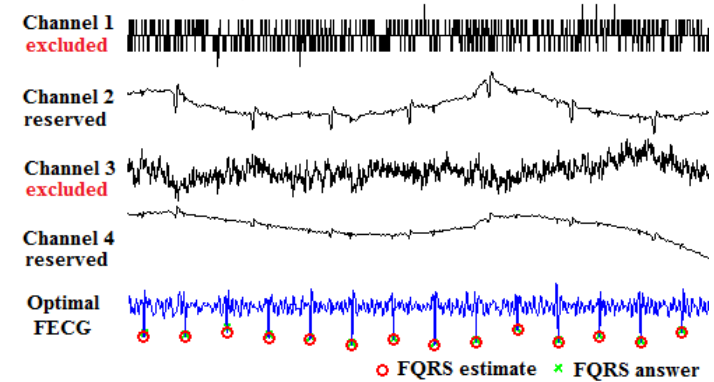

Record a37: raw AECG and optimal FECG

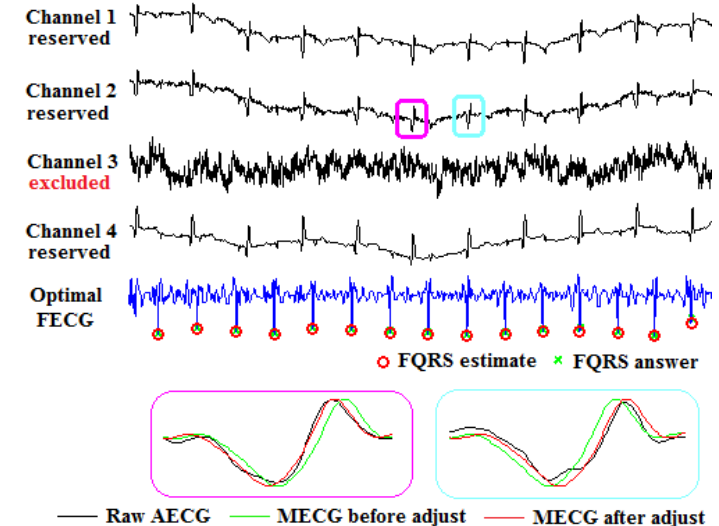

A robust algorithm for fetal heart rate and RR interval calculation using non-invasive maternal abdomen ECG

M. Kropf, R. Modre-Osprian, G. Schreier, D. Hayn

- Approach:
 - Detect maternal QRS [1], subtract averaged QRS [2]
 - Detect fQRS
 - Calculate measure for fQRS detection quality
 - Select parameter set leading to best quality measure
 - Optimize fQRS sequence using statistical methods
- Strengths:
 - Unsupervised selection of best channel and quality
- Weaknesses / future work
 - fQRS detection should be improved to detect regular event sequences instead single events
- Results:
 - Events 1/4 (MSE of fetal HR): 82.438
 - Events 2/5 (RMS of fetal RR): 7.354

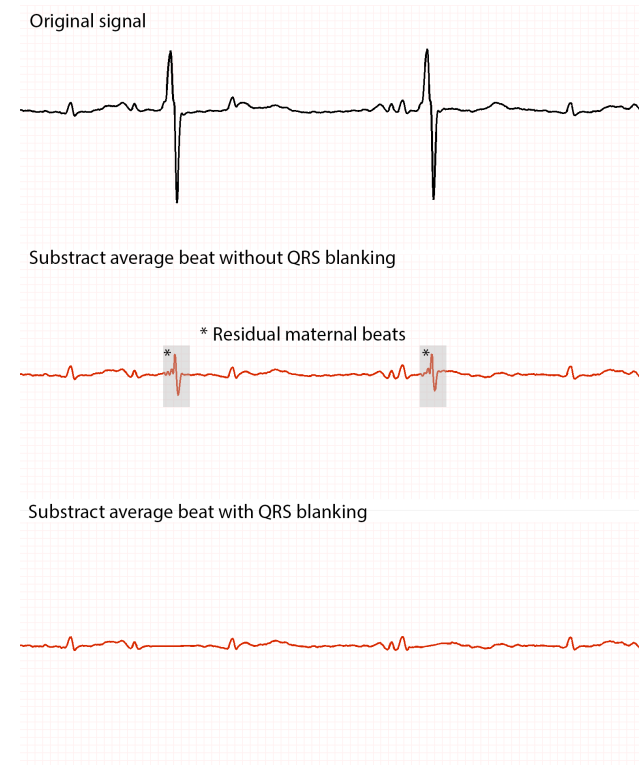

Different approaches to remove maternal ECG

[1] CinC challenge 2004, 1st place, Biomed Tech 2007; 52:5-10

[2] CinC challenge 2011, 1st place, Physiol. Meas. 33 (2012) 1449-1461

Noninvasive multilead FQRS Detection

Vito Starc

Approach:

- Preprocessing: 4 lead signals -> **8 signals**: with **two bandpass filters** (5 - 40 Hz & 1 - 80 Hz)
- **Maternal PQRST cancellation**
- **FQRS detector** with adjustable threshold
- **FQRS filter** for **Outlier rejection** by minimizing error = $\sum (RR_i - \text{median } RR)^2$
- **Final selection**: FQRS series with the minimal error
- Automated analysis, Delphi-Pascal

Strengths:

- Multilead RR assessment better than single lead
- Tolerates loss of 1 to 3 (of 4) ECG signals

Weaknesses:

- Static filtering does not adapt to instant. noise
- QT estimation is unreliable due to filtering

Results:

- Events 1/4 (MSE of Fetal HR): 963, 195, 181
- Events 2/5 (RMS error of FRR): 37.1, 15.4, 10.9

Alternatives studied / future work:

- $\sum (dU/dt_i)^2$ signal better for FQRS detection than SVD
- Future - Matching of instantaneous FQRS to the template

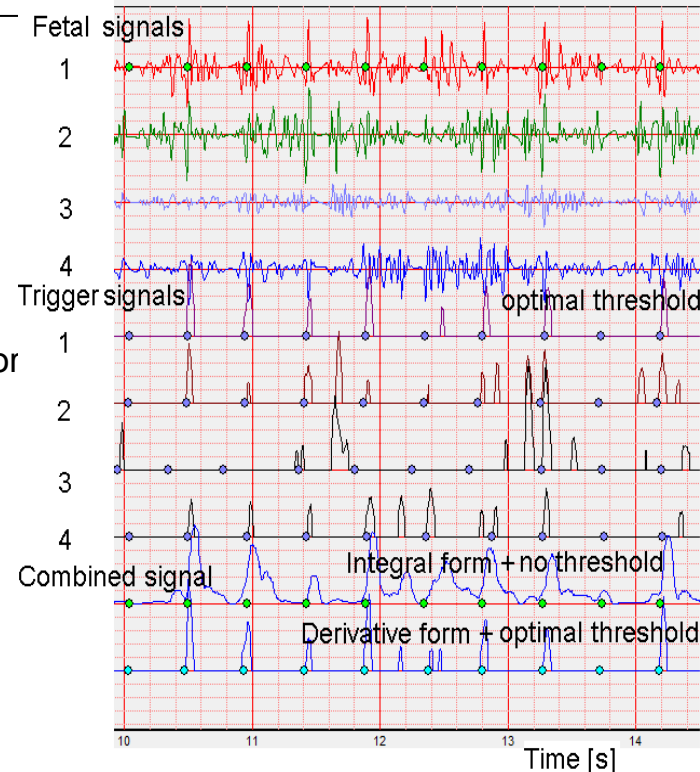

*Fetal signals, Trigger signals
and beat fiducial points*

Identification of Fetal QRS Complexes in Low Density Non-Invasive Biopotential Recordings

Alessia Dessì*, Danilo Pani, Luigi Raffo

Approach:

- Joint filter-based and template matching strategy to identify QRS complexes and maternal QRS template
- Periodicity analysis and correction of the time series
- Clustering to identify maternal annotation
- Maternal QRS template subtraction
- Similar approach to identify fetal QRS complexes

Strengths:

- MEGC cancellation preserves fetal QRS complexes

Weaknesses:

- Too much sensitive to high frequency P/T waves
- Rules for the identification of maternal complexes

Results:

- Events 1/4 (MSE of fetal HR): 648.158 639.465
- Events 2/5 (RMS error of fetal RR): 47.990 23.821

Alternative studies/future work:

- Improve clustering rules
- Improve fetal QRS detection in low SNR signals
- Include the P and T waves in the subtraction of averaged maternal complexes

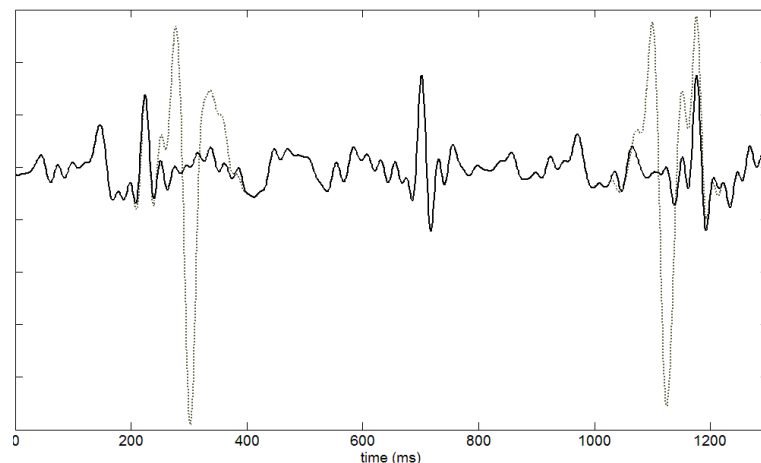
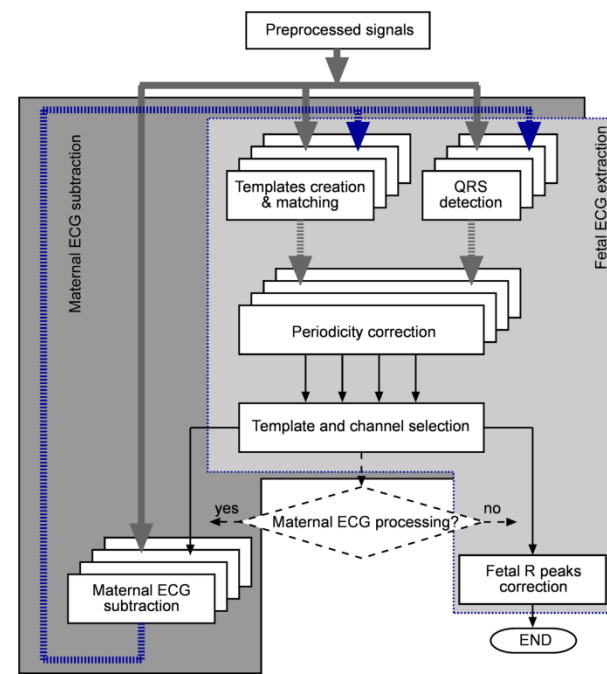

Fetal ECG detection in abdominal recordings: a method for QRS location

Rui Rodrigues

Approach:

- Median filter, Notch and low pass linear filters
- Detect MQRS using *all 4 channels*
- Remove MEG in the *neighbourhood* of each MQRS using adaptive filter
- Peak detector to locate FQRS on each channel
- Choose one of the 4 sets of FQRS detections:
 $\text{Max \{number of detections - 0.5 * std(RR interval)\}}$

Weaknesses:

- Criteria to choose channel from where FQRS detections are taken

Results:

- Event 1: 278.755 -Event 2: 28.201
- Event 4 : 124.803 -Event 5 : 14.351

future work:

- Eliminate steep mother P and T waves (example: a43)
- Reconstruction of MQRS using other methods(neural networks??)
- Criteria to choose channel from where FQRS detections are taken

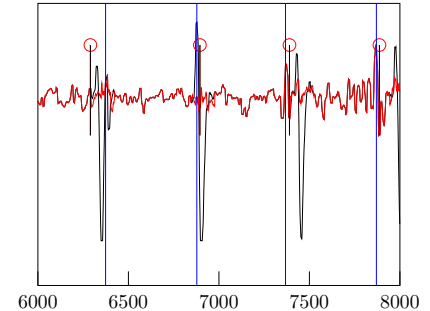

record a03: channel 1

Foetal Heartbeat Detection by Expectation-weighted Estimation of Fiducial Points

LY Di Marco, A Marzo, A Frangi
CISTIB - University of Sheffield, UK

Approach:

- Template-based cancellation of mQRS to obtain rECG
- Band-pass filter to enhance fQRS
- Gaussian distribution to weight expectation (EWE) of next fQRS

Strengths:

- Accurate foetal RR measurement
- Tolerates loss of N-1 signals

Weaknesses:

- Choice of 'best' channel for fQRS
- Assumption of 'fairly stable' fHR

Results:

Event	Phase 1 Score	Final Score
4	135.18	205.01
5	7.11	12.87

Future work:

- Apply EWE to a combination of rECG signals instead of N individual signals
- Improve expectation criterion to account for sudden acceleration/deceleration of fHR

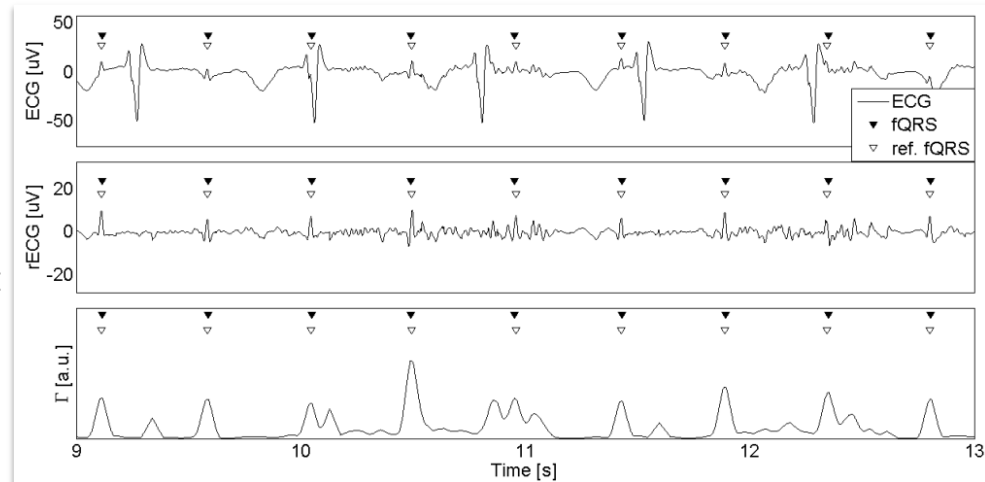

Abdominal ECG (top), residual ECG (central) and filtered signal (bottom)

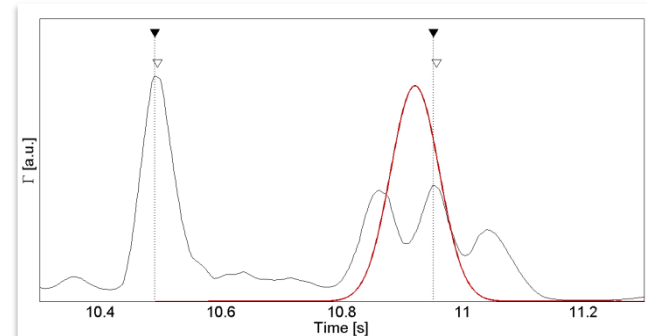

Expectation-weighted estimation of next fQRS

Approach:

- moving median to remove trends
- adaptive RS slope detection to find fQRS
- covariance of fQRS with abdominal ECG to enhance fECG

Strengths:

- multichannel but works also for single channel
- works extremely well for partially noisy signals
- can detect fetal QRS in fused fQRS and mQRS
- universal approach to signals with different properties

Weaknesses:

- QT estimation unreliable
- sloppy noise filtration

Results:

- 118.221 (event 4) and 10.663 (event 5).

Future work:

- cross-covariance of different channels
- better noise filtering

